

Adres: Akkerwinde 1	
Postcode: 5161XL SPRANG-CAPELLE	
Schaal: 1:100	Formaat: A3
Datum: 27-01-2026	Getekend door: CI
ALG-7121-712100010-5161XL-1-Cesp	
Alle maten zijn onder voorbehoud en aan deze tekening kunt u geen rechten ontleen	

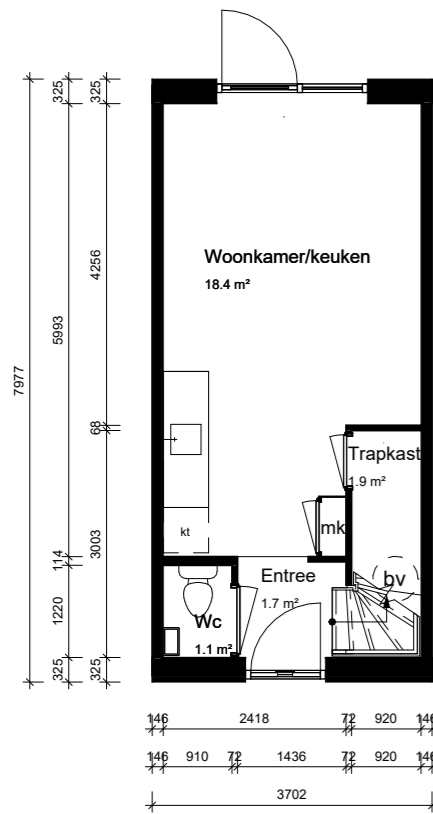

begane grond

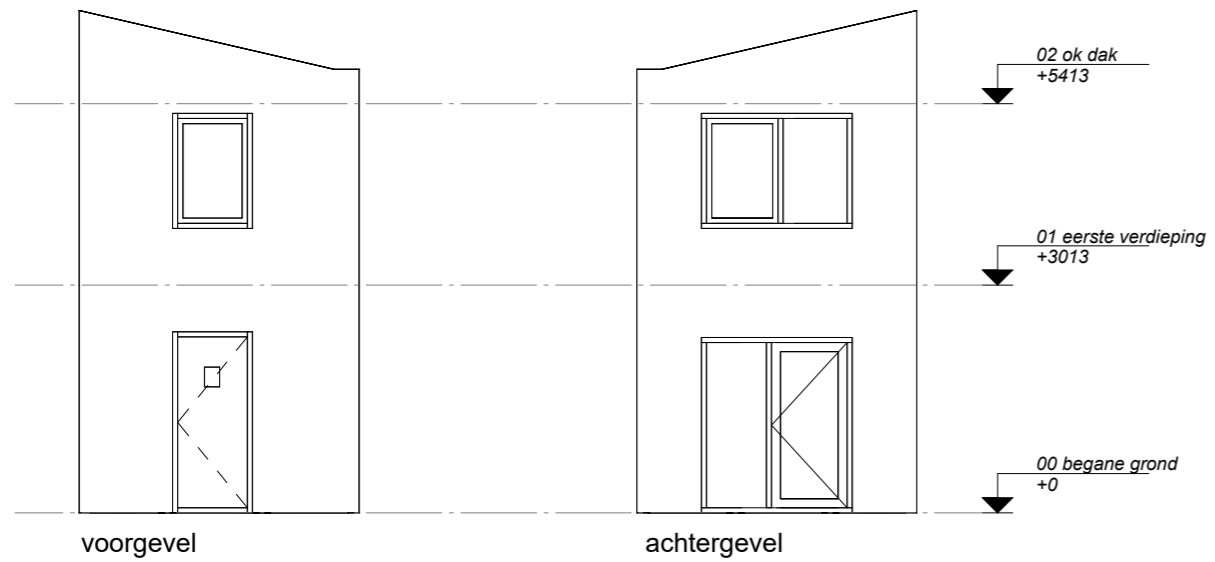
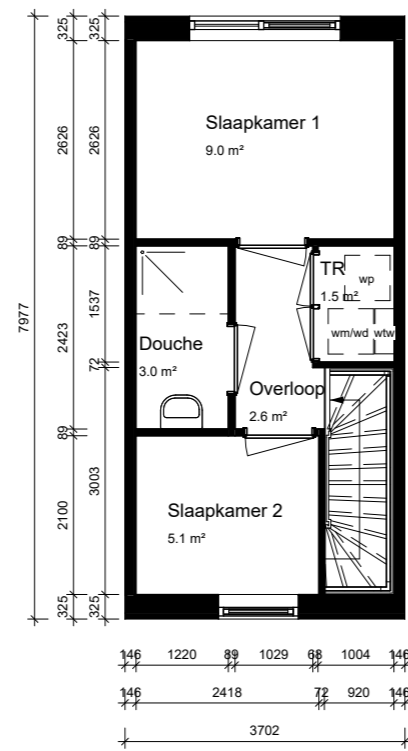

eerste verdieping

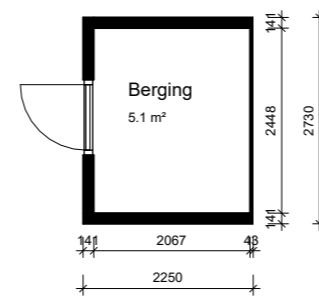

begane grond - berging

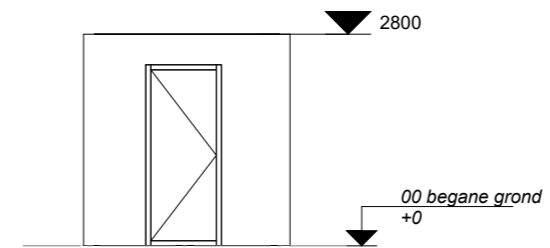

gevel - berging



Adres: Akkerwinde 3	
Postcode: 5161XL SPRANG-CAPELLE	
Schaal: 1:100	Formaat: A3
Datum: 27-01-2026	Getekend door: CI
ALG-7121-712100020-5161XL-3-C	
Alle maten zijn onder voorbehoud en aan deze tekening kunt u geen rechten ontleenen	

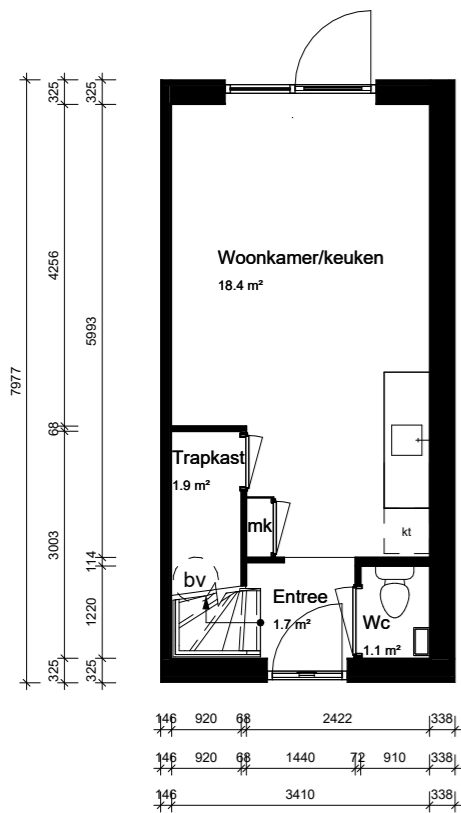
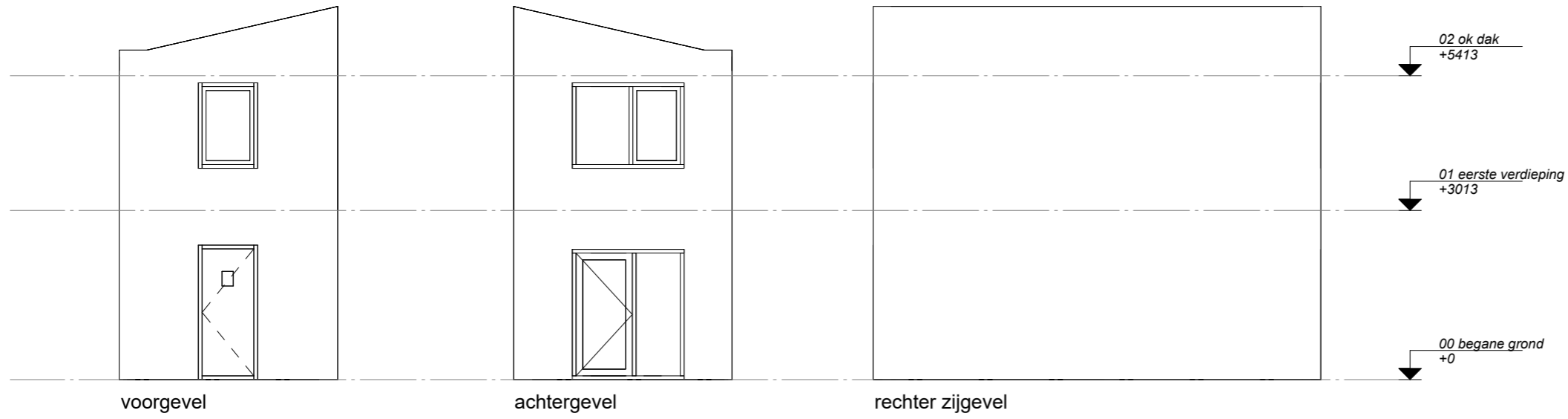

begane grond

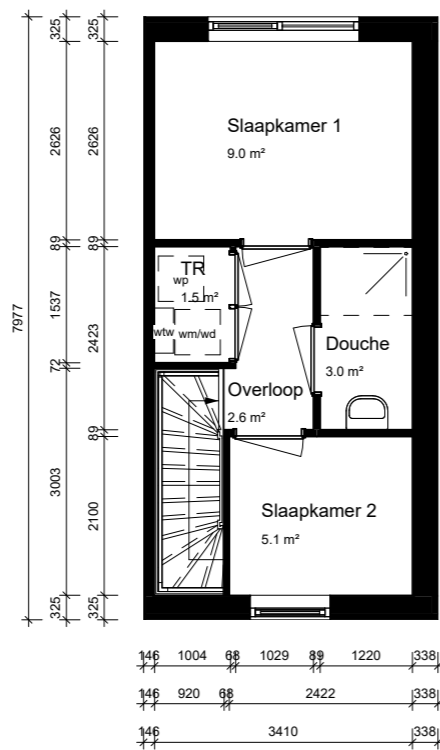

eerste verdieping

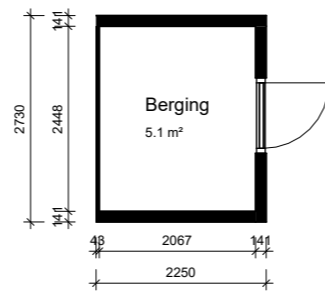

begane grond - berging

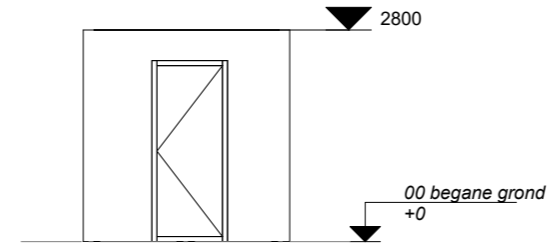

gevel - berging



Adres: Akkerwinde 3a	
Postcode: 5161XL SPRANG-CAPELLE	
Schaal: 1:100	Formaat: A3
Datum: 27-01-2026	Getekend door: CI
ALG-7121-712100030-5161XL-3a-C1esp	
Alle maten zijn onder voorbehoud en aan deze tekening kunt u geen rechten ontleen	

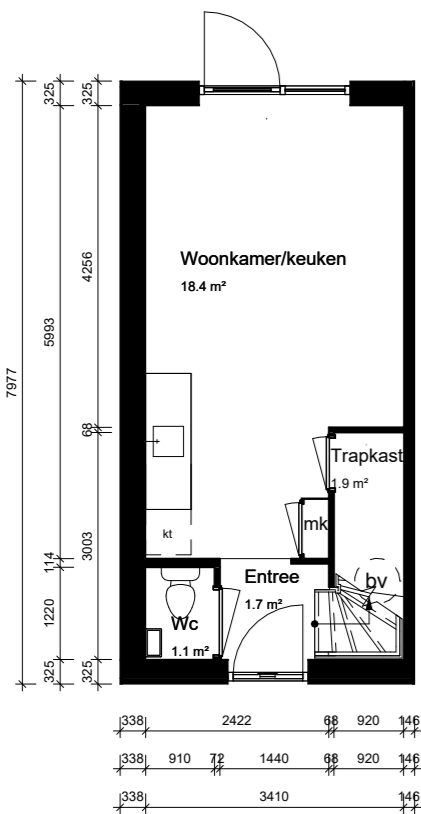
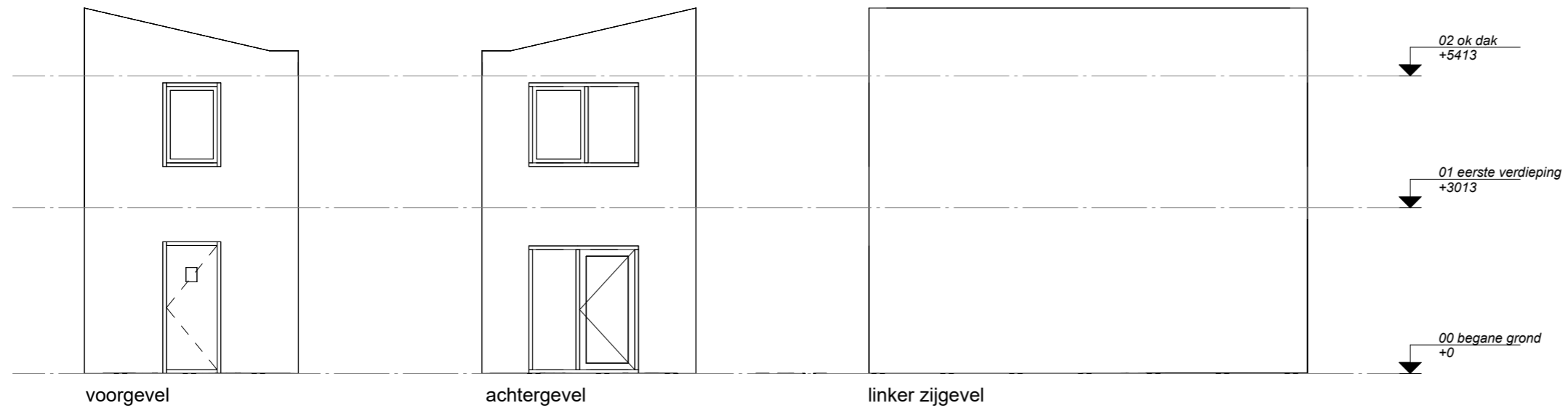

begane grond

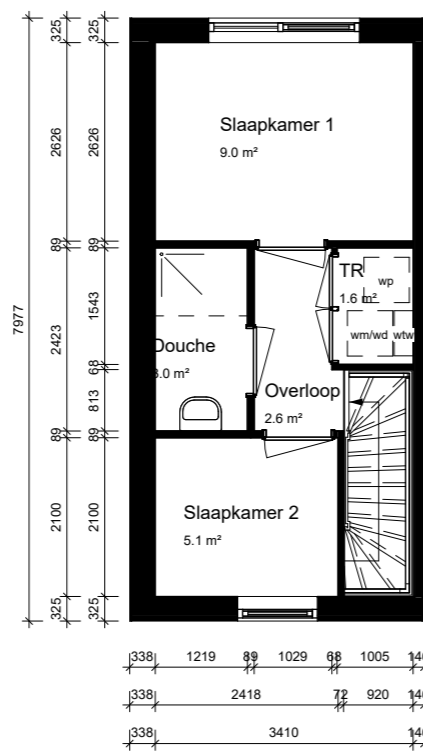

eerste verdieping

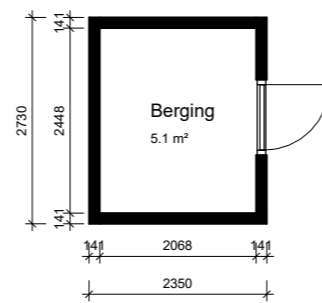

begane grond - berging

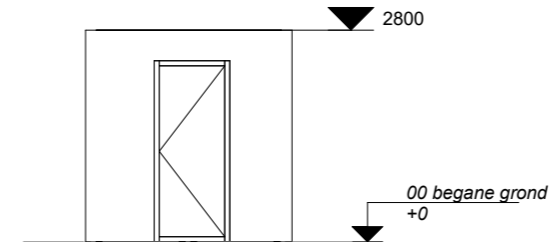

gevel - berging



Adres: Akkerwinde 5	
Postcode: 5161XL SPRANG-CAPELLE	
Schaal: 1:100	Formaat: A3
Datum: 27-01-2026	Getekend door: CI
ALG-7121-712100040-5161XL-S-C1e	
Alle maten zijn onder voorbehoud en aan deze tekening kunt u geen rechten ontleenen	

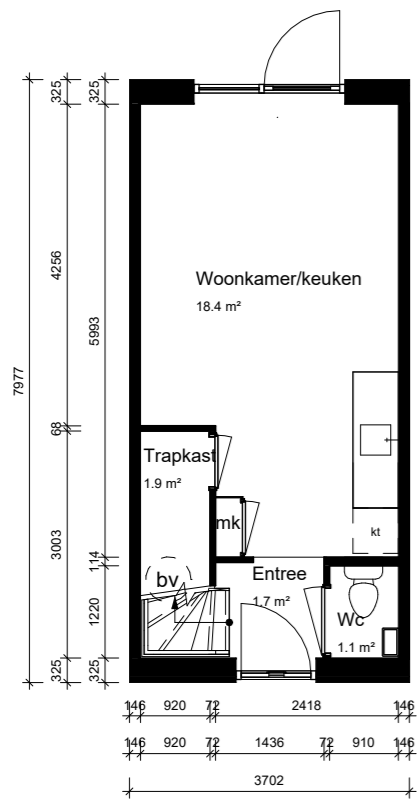
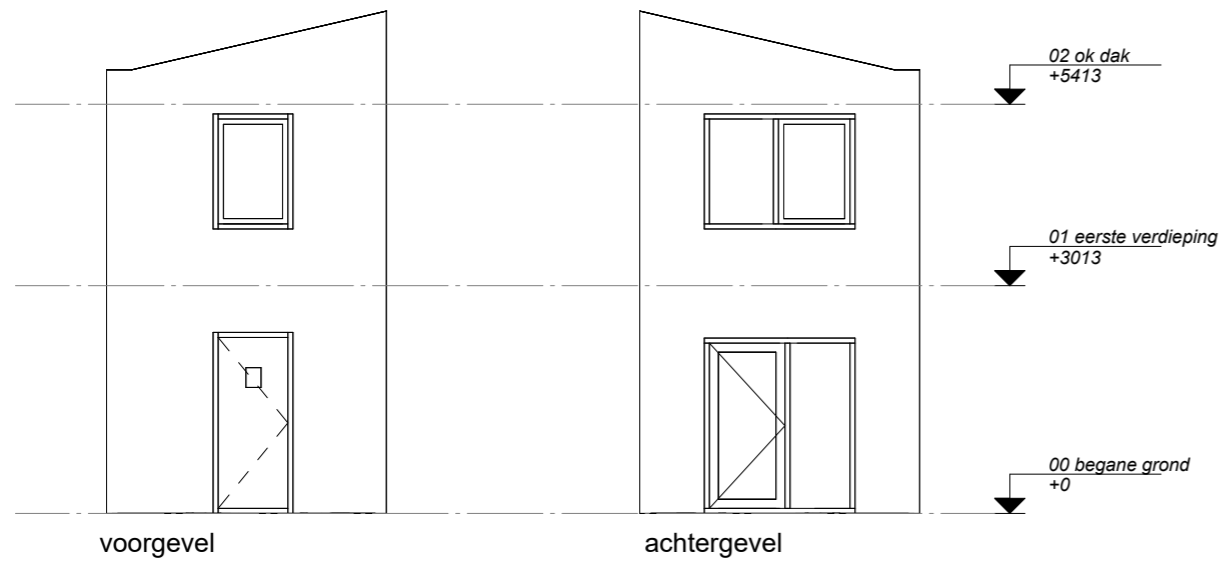

begane grond

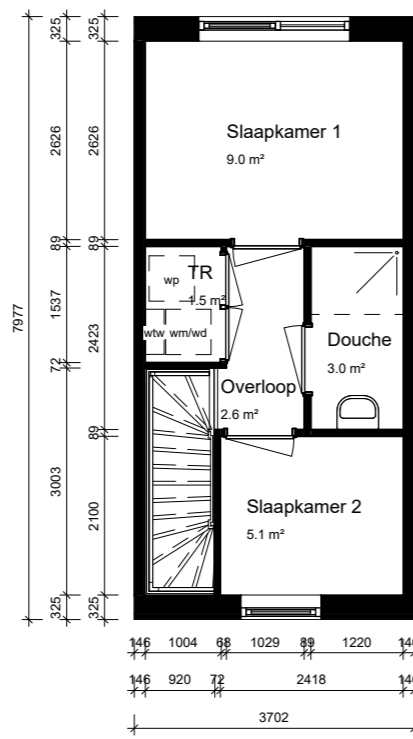

eerste verdieping

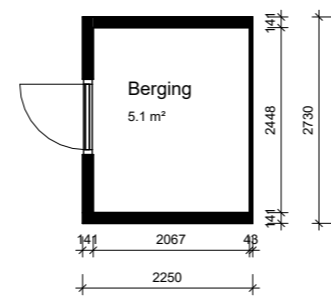

begane grond - berging

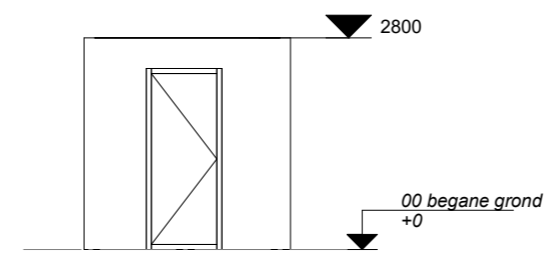

Adres: Akkerwinde 5a	
Postcode: 5161XL SPRANG-CAPELLE	
Schaal: 1:100	Formaat: A3
Datum: 27-01-2026	Getekend door: CI
ALG-7121-712100050-5161XL-Sa-Csp	
Alle maten zijn onder voorbehoud en aan deze tekening kunt u geen rechten ontleenen	

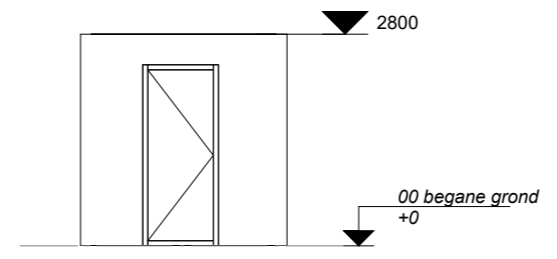
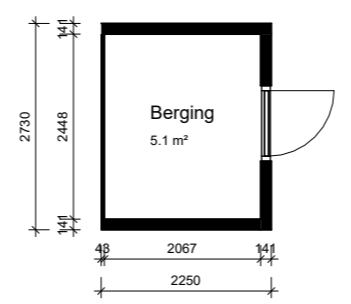
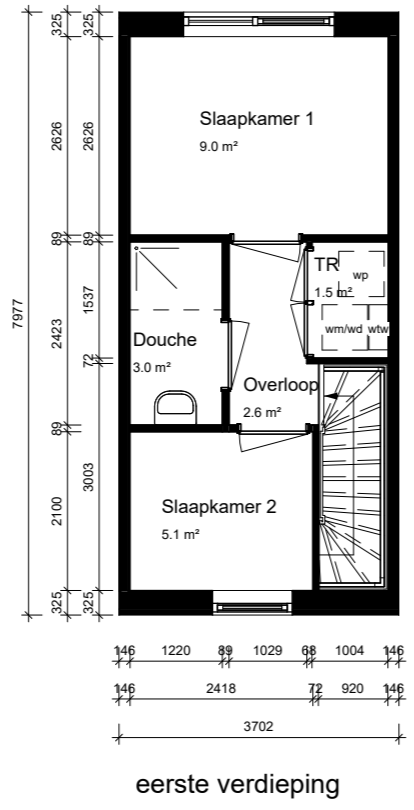
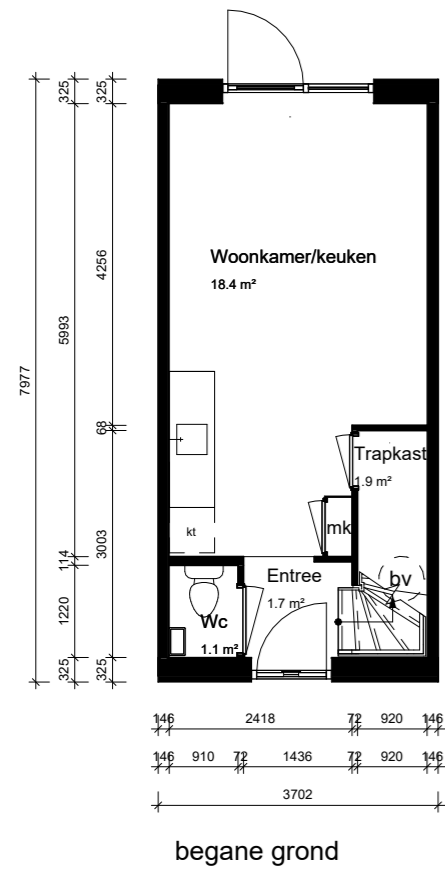
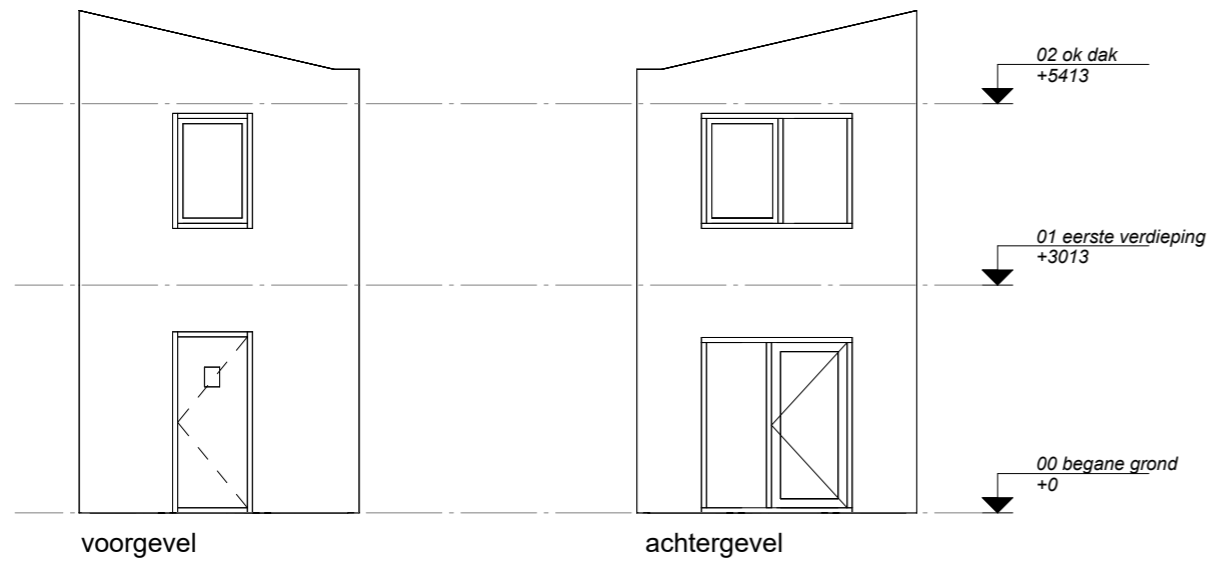

Adres: Akkerwinde 7	
Postcode: 5161XL SPRANG-CAPELLE	
Schaal: 1:100	Formaat: A3
Datum: 27-01-2026	Getekend door: CI
ALG-7121-712100060-5161XL-7-C	
Alle maten zijn onder voorbehoud en aan deze tekening kunt u geen rechten ontlezen	

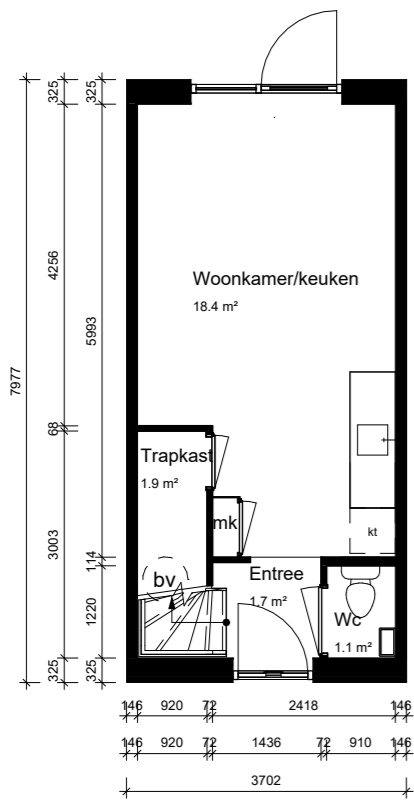
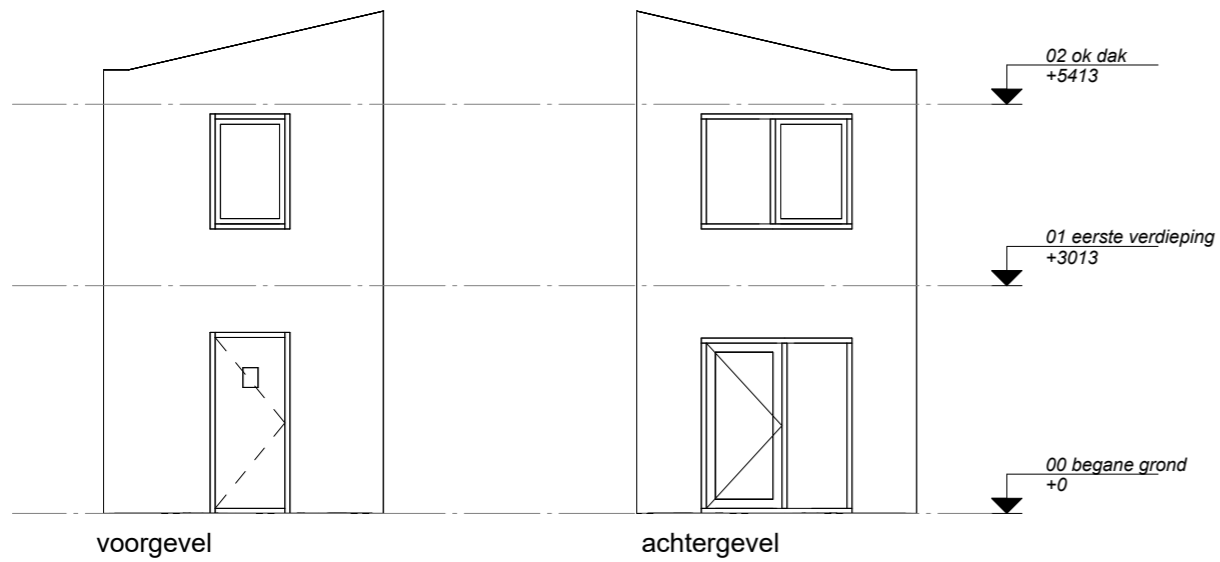

begane grond

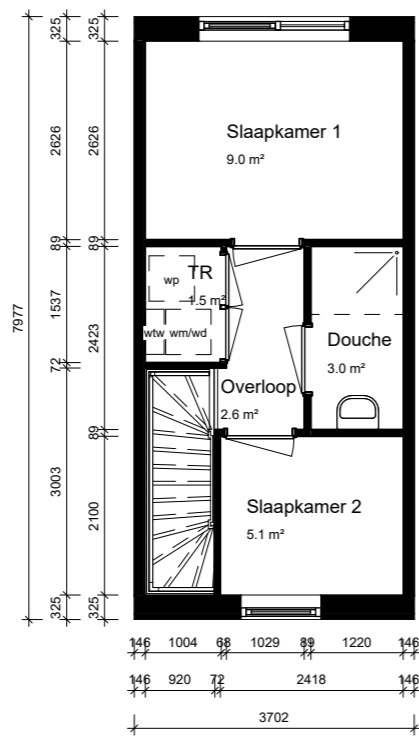

eerste verdieping

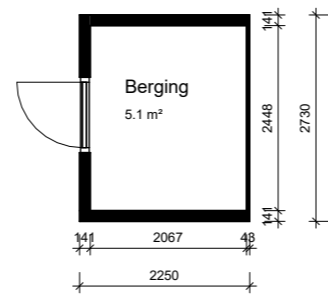

begane grond - berging

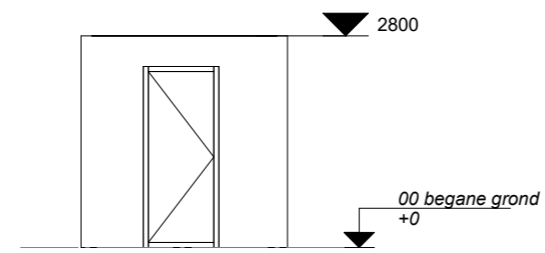

gevel - berging



Adres: Akkerwinde 7a	
Postcode: 5161XL SPRANG-CAPELLE	
Schaal: 1:100	Formaat: A3
Datum: 27-01-2026	Getekend door: CI
ALG-7121-712100070-5161XL-7a-Csp	
Alle maten zijn onder voorbehoud en aan deze tekening kunt u geen rechten ontleenen	

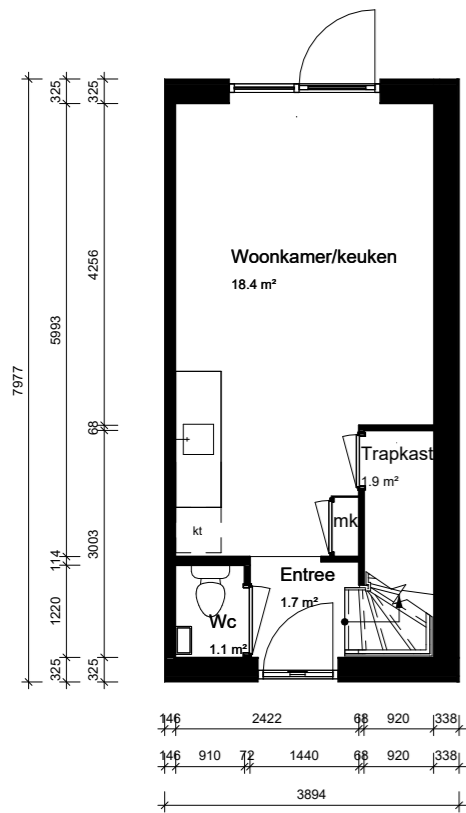
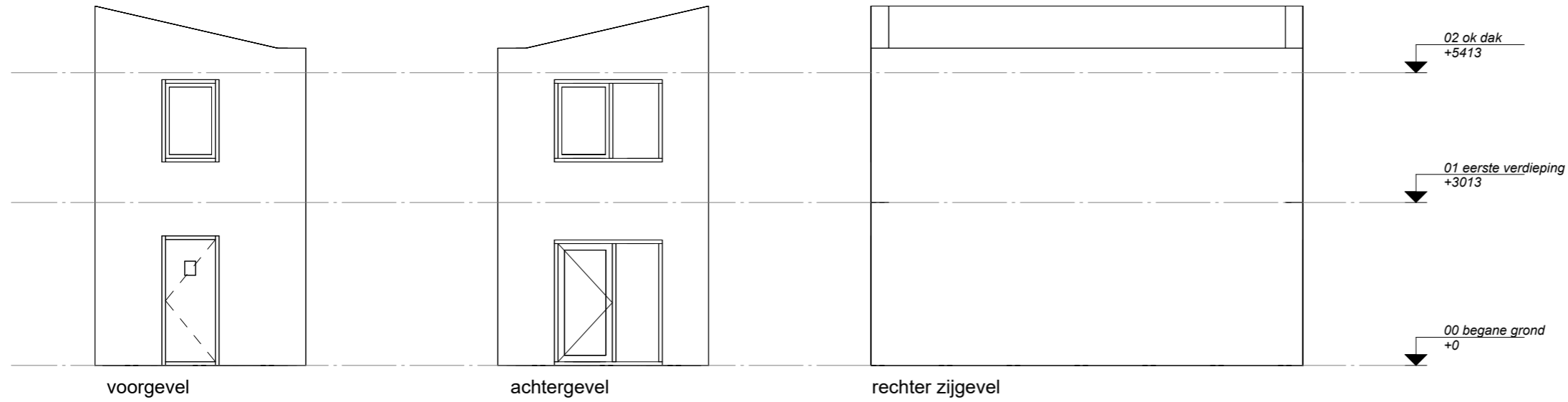

begane grond

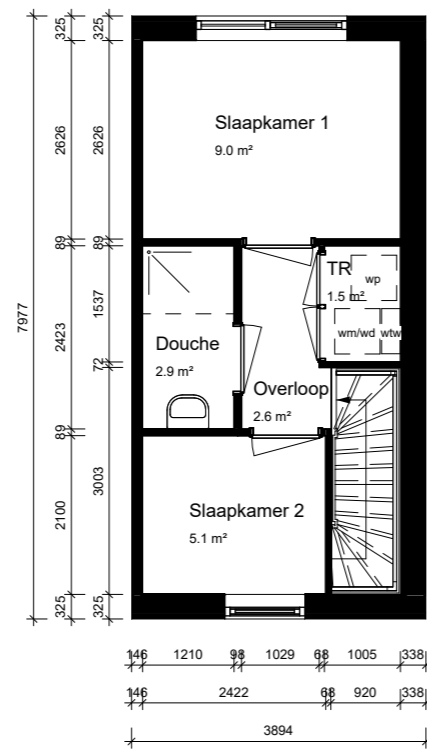

eerste verdieping

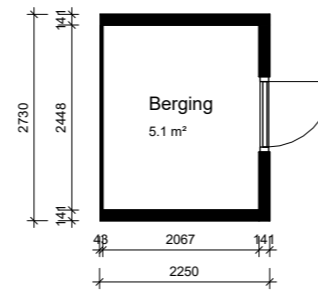

begane grond - berging

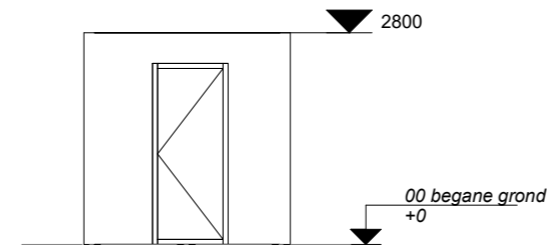

gevel - berging



Adres: Akkerwinde 9	
Postcode: 5161XL SPRANG-CAPELLE	
Schaal: 1:100	Formaat: A3
Datum: 27-01-2026	Getekend door: CI
ALG-7121-712100080-5161XL-9-Ce	
Alle maten zijn onder voorbehoud en aan deze tekening kunt u geen rechten ontleenen	